

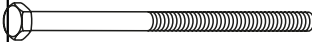









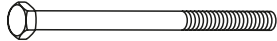





Automaten Hoffmann

Billardtisch „Excellent“ (8ft)

Montageanleitung zu Art.Nr. 6600,
6601, 6602

Billard

Bauteile (Hardware)				
Paket	Art.-Nr.	Abbildung	Bezeichnung	Menge
Beine	H1		Schraube (M10X150mm)	16
	H2		Unterlegscheibe	32
	H3		Mutter	16
Querstrebe/Rahmen	H4		Schraube (M10X130mm)	4
	H5		Unterlegscheibe	4
	H6		Mutter	4
	H7		Schraube (M8X50mm)	4
	H8		Unterlegscheibe	4
	H9		Schraube (M8X80mm)	16
	H10		Unterlegscheibe	16
Bandenrahmen/Ballauffangtaschen/ Schiefer	H11		Schraube (M5X48mm)	16
	H12		Bolzen (M8X140mm)	2
	H13		Bolzen (M8X88mm)	4
	H14		Unterlegscheibe	12
	H15		Mutter	12
	H16		Schraube (M8X25mm)	16
	H17		Unterlegscheibe	16









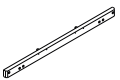
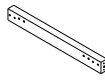

Bauteile (Hardware)				
Paket	Art.-Nr.	Abbildung	Bezeichnung	Menge
Beine	1		Bein	4
Rahmen	2		Rahmenteil lange Seite	2
	3		Rahmenteil kurze Seite	2
	4		lange Seitenverblendung	2
	5		kurze Seitenverblendung	2
	6		Eckverbinder	4
	7		Holzblock lange Seite	4
	8		Holzblock kurze Seite	4
Streben	9		Querstrebe	2
Bandenrahmen	10		Bodenrahmen lange Seite	2
	11		Bodenrahmen lange Seite	2
	12		Bodenrahmen kurze Seite	2
Ballauffangtaschen	13		Seitentasche	2
	14		Ecktasche	4
Schiefer	15		Schieferplatte (links)	1
	16		Schieferplatte (mitte)	1

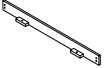
Abb.3

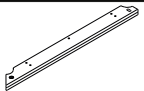
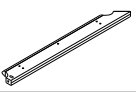

Abb.4

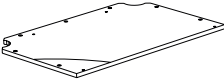
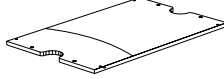

Abb.5

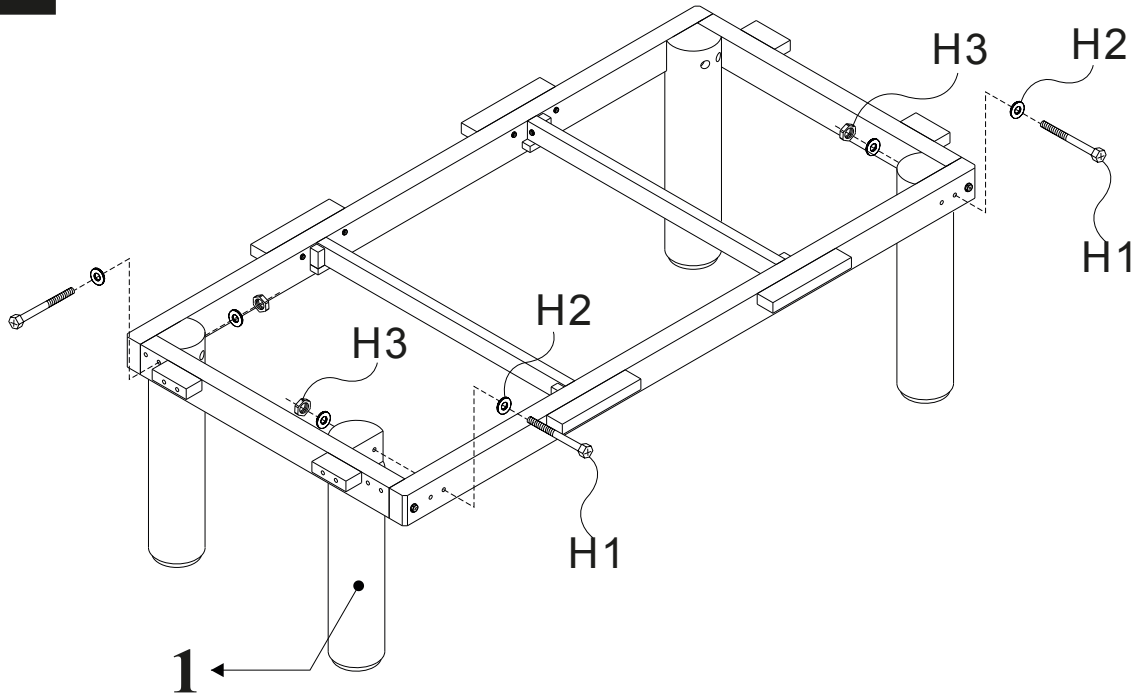

Abb.6

Schneiden Sie Löcher in das Tuch für die Schrauben.

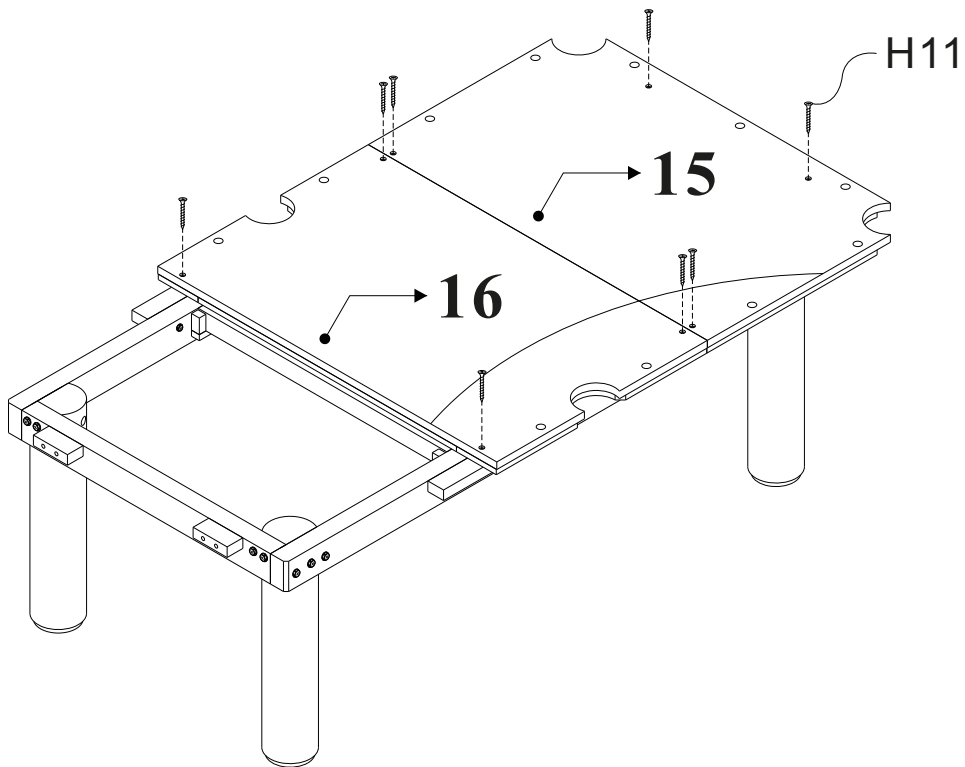

Geschafft

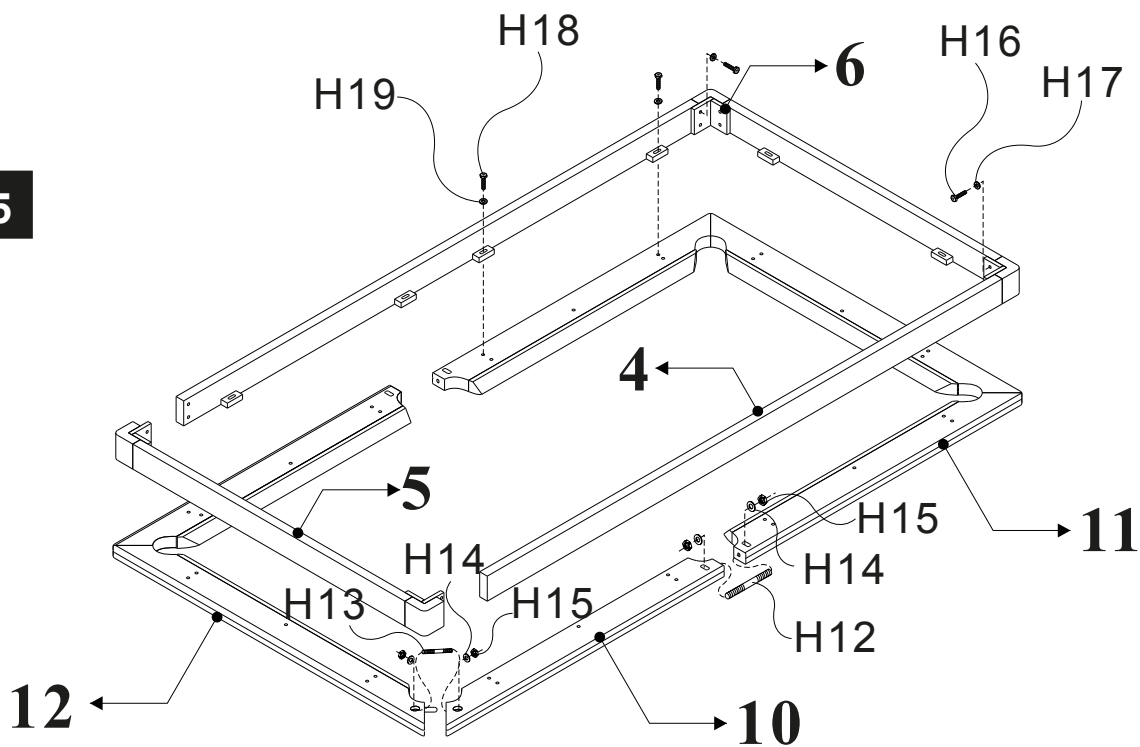
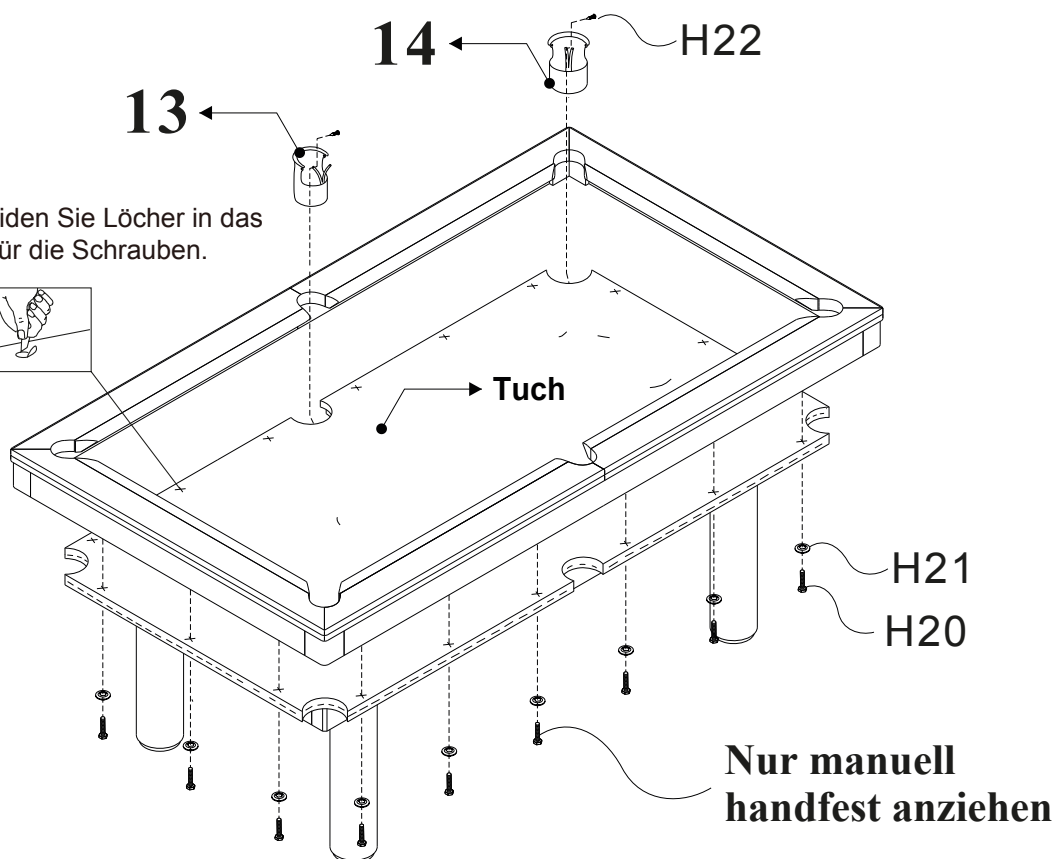
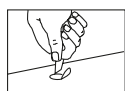
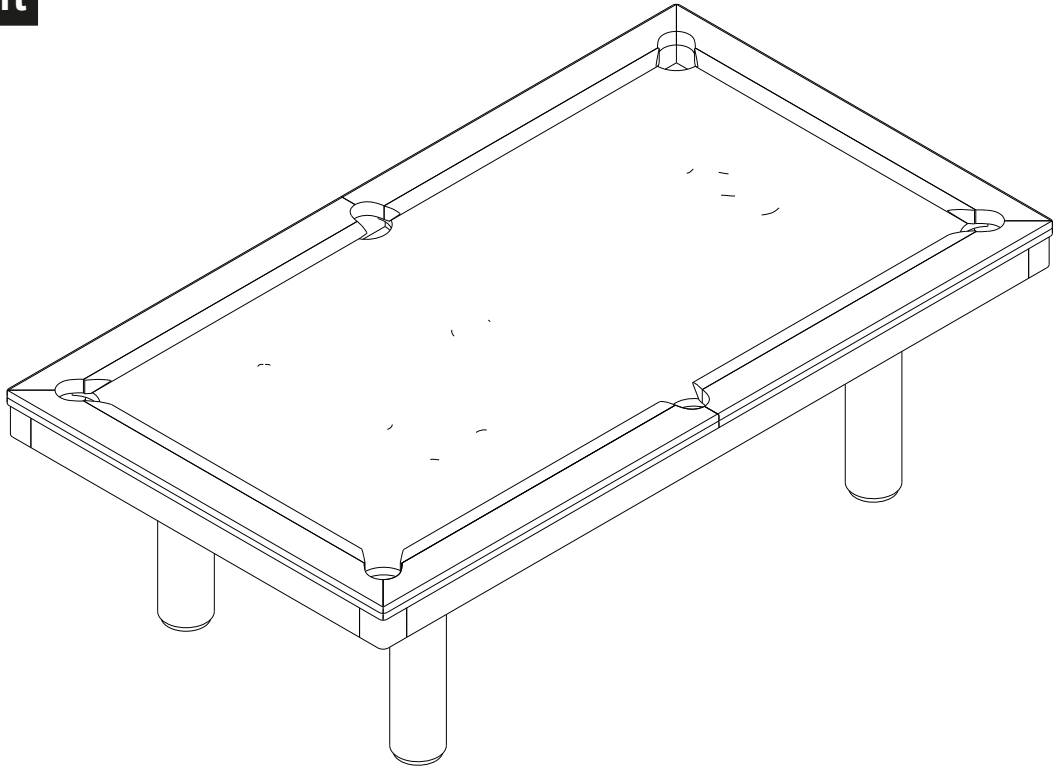

Vielen Dank, dass Sie sich für ein Automaten Hoffmann Produkt entschieden haben.
Bei Fragen stehen wir Ihnen gerne zur Verfügung.



Im Teelbruch 77 · D-45219 Essen
Telefon 02054 16738 · Fax 02054 83094
info@automaten-hoffmann.de · automaten-hoffmann.de